

FCI CONFIDENTIAL

FCI  
FCIconnect.com

This document is the property of and embodies CONFIDENTIAL and PROPRIETARY information of FCI. No part of the information shown on this document may be used in any way or disclosed to others without the written consent of FCI.  
Copyright FCI

PRODUCT NO.  
88640-\*\*\*  
88640-\*\*\*LF

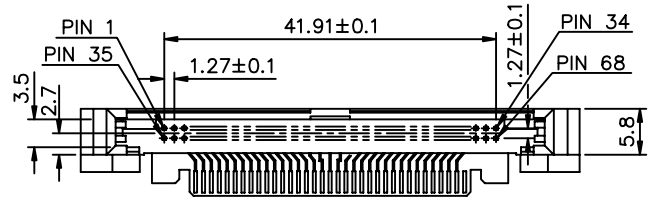
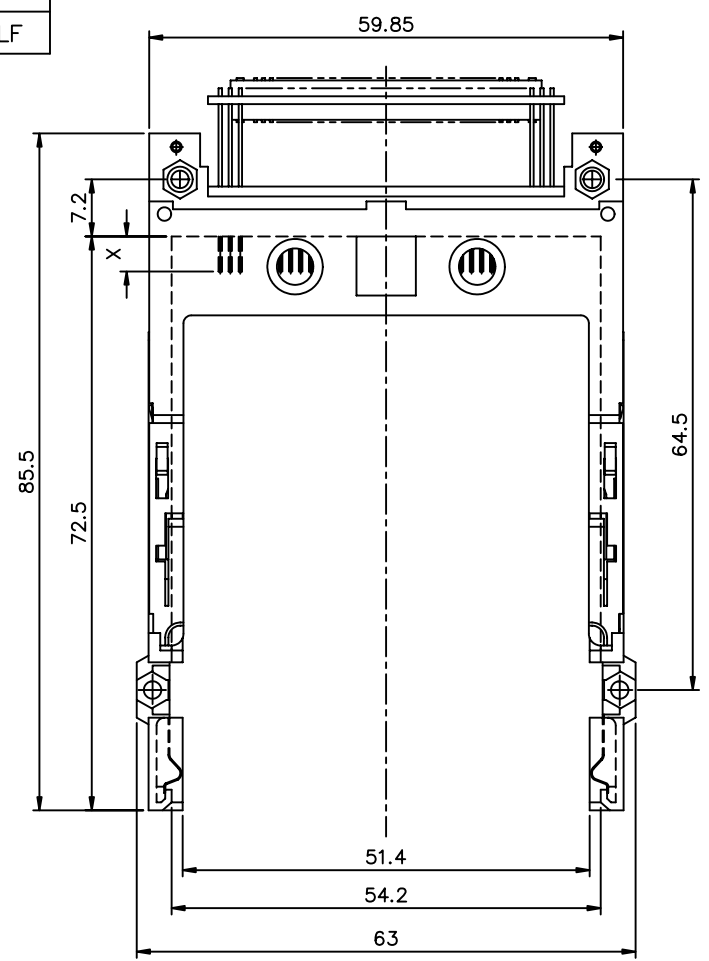

ABOVE P.C.B(P.C.B LAYOUT SEE PAGE 3,4)

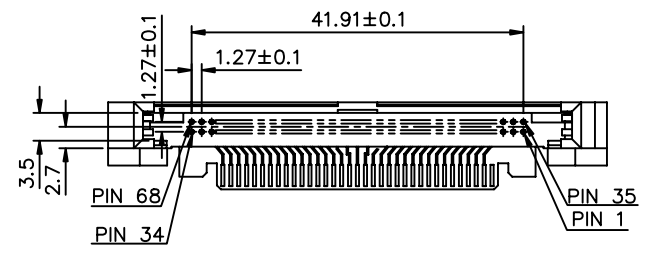
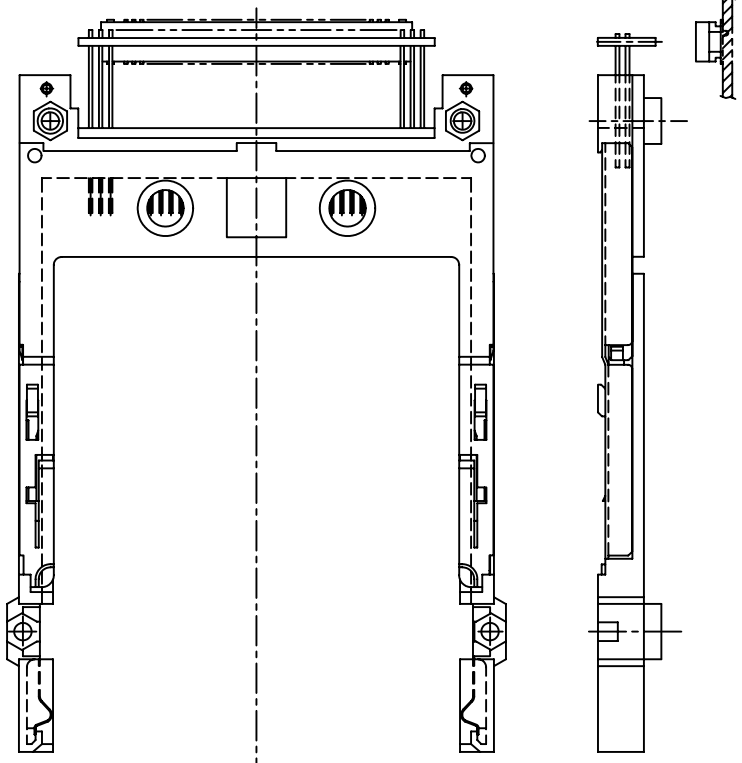
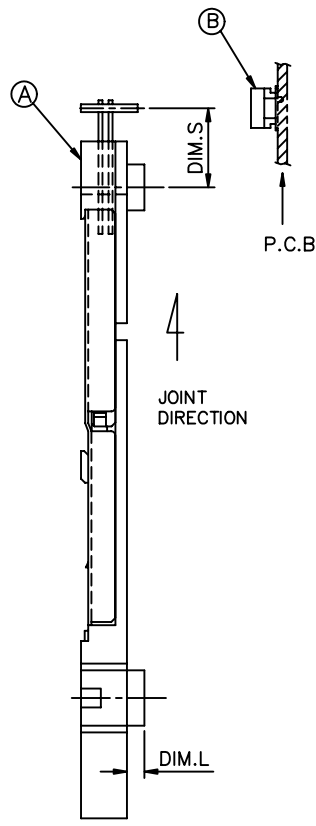

BELOW P.C.B( P.C.B LAYOUT SEE PAGE 5,6)

mat'l. code		surface		tolerance		projection		product family	
		ISO 1302		ISO 406 ISO 1101		1:1		EJECTOR HEADER ASS'Y 68POS. SMT TYP 1/2/3	
ltr	ecm no	dr	date	tolerances unless otherwise specified		MM		title	
E	T90210	W L	05/24/99	angles	linear	±0.30		EJECTOR HEADER ASS'Y 68POS. SMT TYP 1/2/3	
F	T04-0205	W L	05/13/04	±2'		scale 1:1		dwg no 88640 sheet 1 of 6 size A4	
G	N05-0156	W B	06/15/05					type CUSTOMER Drawing	
H	N08-0099	MZ	12/11/07	dr	WENDY CHEN	12/19/95			
				enr	JOSEPH HSIA	12/19/95			
				chr	JOSEPH HSIA	12/19/95			
				appd	JENN TSAO	12/19/95			
sheet	revision	H	H	H	H	H	H		
index	sheet	1	2	3	4	5	6		

1

2 3

4

5

6

BELOW	0	88640-155/155LF	91931-31169 91931-31169LF	6.55	NO	LAYOUT 6-1
	5	88640-150/150LF		-0.3	YES	LAYOUT 6-2
	0	88640-145/145LF		6.55	NO	LAYOUT 6-1
	4.3	88640-143/143LF		-0.3	YES	LAYOUT 6-2
	0	88640-125/125LF		9.0	NO	LAYOUT 5-1
	2.2	88640-122/122LF		2.15	YES	LAYOUT 5-2
	0	88640-100/100LF		10.0	NO	LAYOUT 4
ABOVE	0	88640-055/055LF	91931-31169 91931-31169LF	6.55	NO	LAYOUT 3-1
	5	88640-050H/050HLF		-0.3	YES	LAYOUT 3-2
	5	88640-050/050LF		-0.3	YES	LAYOUT 3-2
	5	88640-051/051LF		-0.3	YES	LAYOUT 3-2
	0	88640-045/045LF		6.55	NO	LAYOUT 3-1
	4.3	88640-043/043LF		-0.3	YES	LAYOUT 3-2
	0	88640-025/025LF		9.0	NO	LAYOUT 2-1
	2.2	88640-022/022LF		2.15	YES	LAYOUT 2-2
	0	88640-000/000LF		10.0	NO	LAYOUT 1
	P.C.B. SIDE ①	DIM. L		Ⓐ EJECT HEADER ASS'Y	Ⓑ CONAN RECEPTACLE	DIM.S

NOTES:

- P.C.B SIDE ARE AS APPEARS INSTALLED.
- MATERIAL
- 2.1 HEADER ASS'Y :  
 PLASTIC :HOUSING ...LCP UL94V-O BLACK(ABOVE P.C.B)  
 ...LCP UL94V-O NATURAL(BELOW P.C.B)  
 PIN :COPPER ALLOY  
 PCB : FR4
- 2.2 EJECT MECHANISM ASS'Y :  
 PLASTIC :GUIDE:POLYPHTHARAMID UL94V-O BLACK  
 PLATE :STAINLESS  
 EMI CONTACT:PHOSPHOR BRONZE
3. FINISH (PIN)  
 UNDER PLATING :0.5 um MIN. Ni  
 1.27um Ni (ONLY FOR 88640-051LF)  
 CONTACT AREA :0.1 um MIN. GOLD OVER 0.5 um MIN. Pd-Ni  
 0.76 um MIN. GOLD.(FOR 88640-051LF)  
 SOLDER TAIL : 2.5 um MIN. Sn-Pb  
 : 2.5 um MIN. PURE Sn (FOR -\*\*\*\*LF)
4. DIM "X"  

4.25±0.1	3.5±0.1	5.0±0.1
OTHERS	36,67	1,17,34,35,51,68
5. DO NOT TOUCH AND KEEP CLEAN THE SURFACES OF P.C.B OF HEADER.
6. ADD "H" TO PART NUMBER FOR OPTIONAL HOLD DOWN (4 PER ASSEMBLY IN EJECT MECHANISM AND HEADER)
7. IF LEAD FREE P.N.THE HOUSING WILL WITHSTAND EXPOSURE TO 260°C PEAK TEMPERATURE FOR 10 SECONDS IN A WAVE SOLDER APPLICATION WITH A 1.00MM MINIMUM THICK CIRCUIT BOARD.
8. IF LEAD FREE P/N.THE PRODUCT MEETS EUROPEAN UNION DIRECTIVES AND OTHER COUNTRY REGULATIONS AS DESCRIBED IN GS-22-008
9. LEAD FREE P/N PACKAGING MEETS GS-14-920 SPECIFICATION

ORDERING INFORMATION

NAME	PART NO.	Q'TY
Ⓐ EJECT HEADER ASS'Y	88640-XXXX	1
Ⓑ MATING RECEPTACLE	91931-31169	1

NAME	PART NO.	Q'TY
Ⓐ EJECT HEADER ASS'Y	88640-XXXXLF	1
Ⓑ MATING RECEPTACLE	91931-31169LF	1

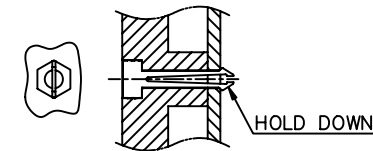

mat'l. code		surface	tolerance	projection	product family
		ISO 1302	ISO 406 ISO 1101		
ltr	ecn no	dr	date	tolerances unless otherwise specified	
H				angles	linear
				±0.30	MM
				±2'	scale 1:1
		dr	WENDY CHEN	12/19/95	title EJECTOR HEADER ASS'Y 68POS. SMT TYP 1/2/3 dwg no 88640 sheet 2of 6 size A4 type CUSTOMER Drawing
		enrg	JOSEPH HSIA	12/19/95	
		chr	JOSEPH HSIA	12/19/95	
		appd	JENN TSAO	12/19/95	
sheet	revision				
index	sheet				

1

2

3

6

FCI CONFIDENTIAL

This document is the property of and embodies CONFIDENTIAL and PROPRIETARY information of FCI. No part of the information shown on this document may be used in any way or disclosed to others without the written consent of FCI.  
Copyright FCI

USED FOR 88640-022 WITH 88640-025  
USED FOR 88640-022LF WITH 88640-025LF

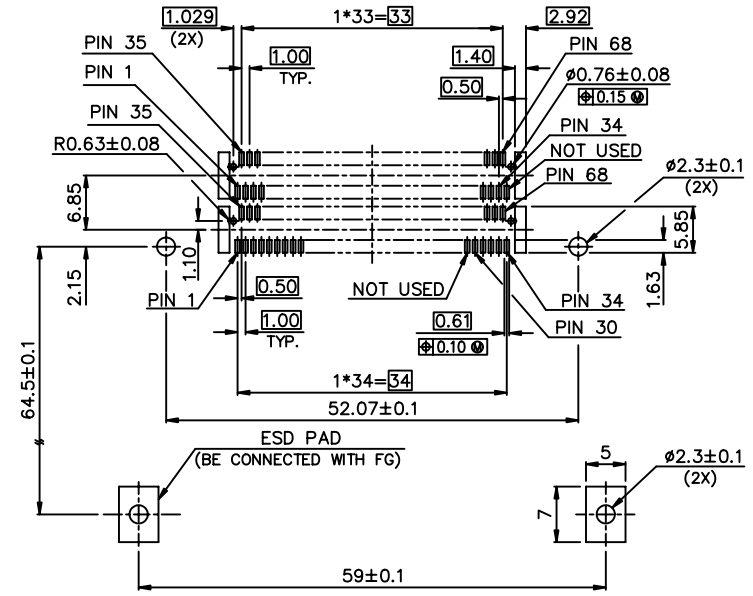

RECOMMENDED P.C.B. LAYOUT 2-1(MOUNTED SIDE)

USED FOR 88640-000 WITH 92789-002  
USED FOR 88640-000LF WITH 92789-002LF

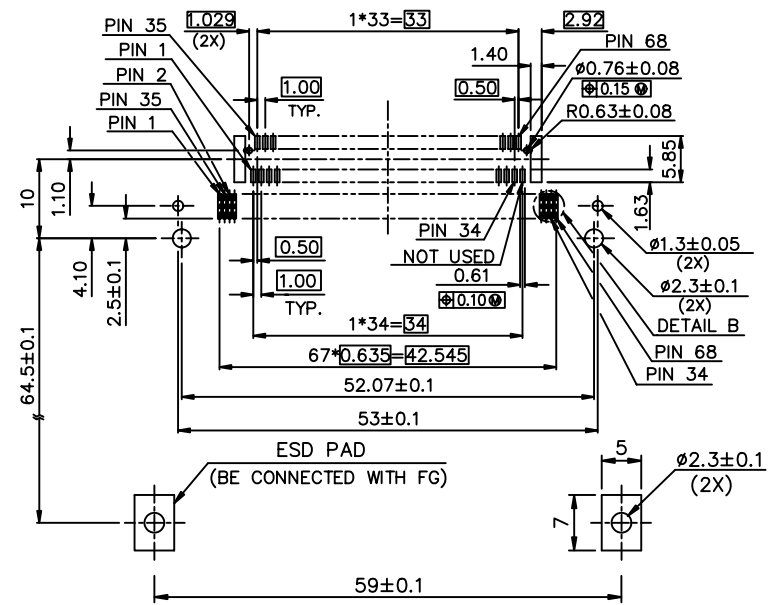

RECOMMENDED P.C.B. LAYOUT 1 (MOUNTED SIDE)

USED FOR 88640-022 /022LF

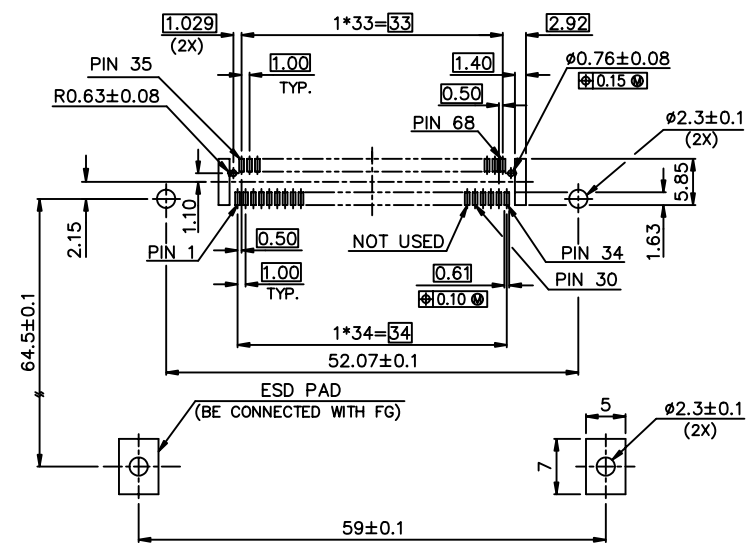

RECOMMENDED P.C.B. LAYOUT 2-2(MOUNTED SIDE)

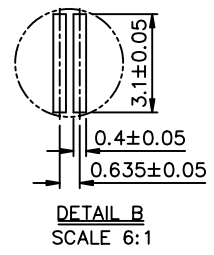

mat'l. code		surface		tolerance		projection		product family	
		ISO 1302		ISO 406 ISO 101					
ltr		ecn no		dr		date		title	
H								EJECTOR HEADER ASS'Y 68POS. SMT TYP 1/2/3	
		angles		linear		± 0.30		MM	
		±2'						scale 1.4:1	
		dr		WENDY CHEN		12/19/95		dwg no	
		enr		JOSEPH HSIA		12/19/95		sheet 3of 6 size	
		chr		JOSEPH HSIA		12/19/95		88640	
		appd		JENN TSAO		12/19/95		A4	
sheet		revision						type	
index		sheet						CUSTOMER Drawing	



FCI CONFIDENTIAL

USED FOR 88640-122 WITH 88640-125  
 USED FOR 88640-122LF WITH 88640-125LF

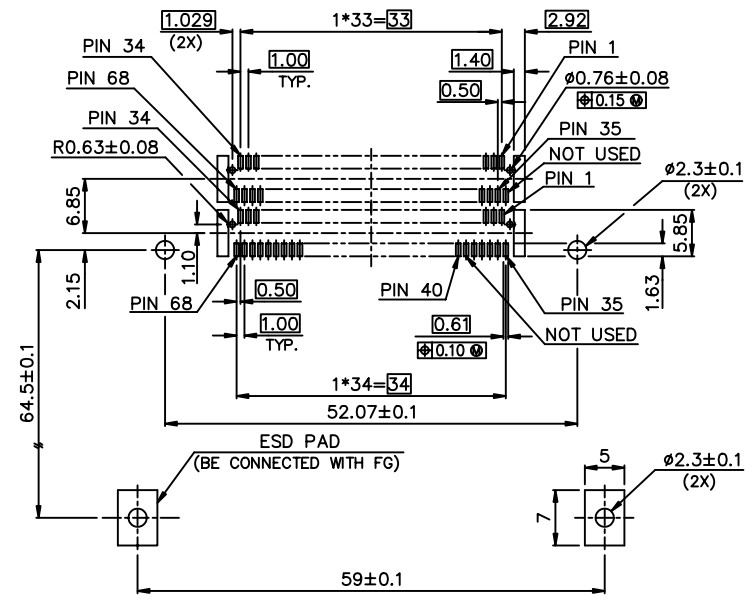

RECOMMENDED P.C.B. LAYOUT 5-1 (MOUNTED SIDE)

USED FOR 88640-100 WITH 92789-502  
 USED FOR 88640-100LF WITH 92789-502LF

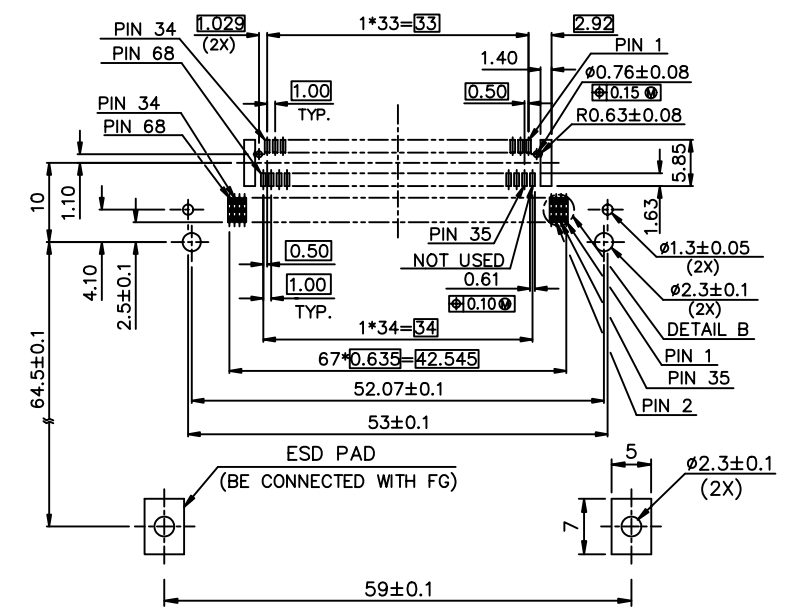

RECOMMENDED P.C.B. LAYOUT 4 (MOUNTED SIDE)

USED FOR 88640-122/122LF

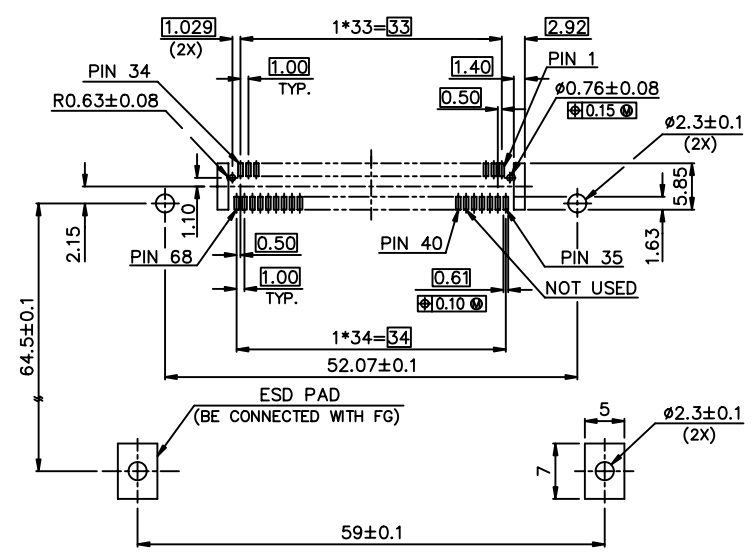

RECOMMENDED P.C.B. LAYOUT 5-2 (MOUNTED SIDE)

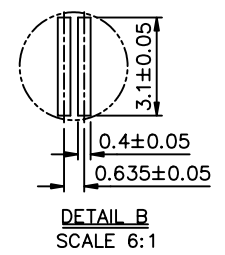

mat'l. code		surface		tolerance		projection		product family	
		ISO 1302		ISO 406 ISO 101					
ltr		ecn no		dr		date		title	
H								EJECTOR HEADER ASS'Y 68POS. SMT TYP 1/2/3	
		angles		linear		± 0.30		scale 1.4:1	
		±2'						dwg no 88640 sheet 5 of 6 size A4	
		dr		WENDY CHEN		12/19/95		FCI	
		enr		JOSEPH HSIA		12/19/95			
		chr		JOSEPH HSIA		12/19/95			
		appd		JENN TSAO		12/19/95		type CUSTOMER Drawing	
sheet index		revision sheet							

This document is the property of and embodies CONFIDENTIAL and PROPRIETARY information of FCI. No part of the information shown on this document may be used in any way or disclosed to others without the written consent of FCI. Copyright FCI.

FCI CONFIDENTIAL

USED FOR 88640-143 WITH 88640-145  
 USED FOR 88640-150 WITH 88640-155

USED FOR 88640-143LF WITH 88640-145LF  
 USED FOR 88640-150LF WITH 88640-155LF

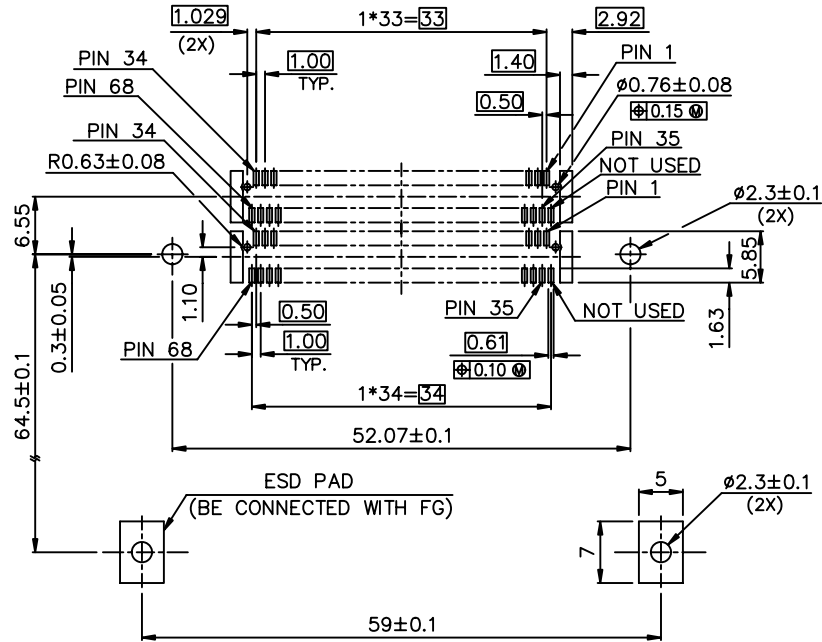

RECOMMENDED P.C.B. LAYOUT 6-1 (MOUNTED SIDE)

USED FOR 88640-143  
 USED FOR 88640-150  
 USED FOR 88640-143LF  
 USED FOR 88640-150LF

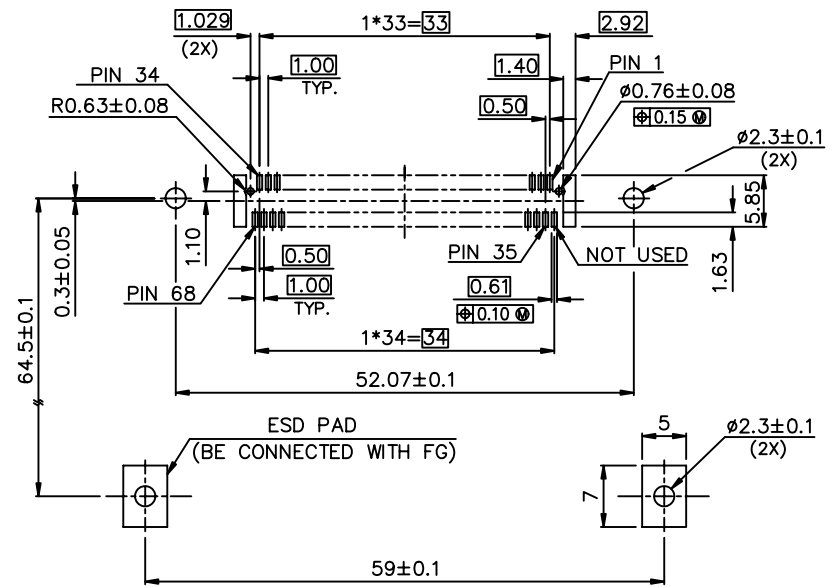

RECOMMENDED P.C.B. LAYOUT 6-2 (MOUNTED SIDE)

mat'l. code		surface ISO 1302		tolerance ISO 406 ISO 1101		projection 1:1		product family	
ltr		ecm no		dr		date		title	
H				angles		linear		EJECTOR HEADER ASS'Y 68POS. SMT TYP 1/2/3	
				±2'		± 0.30		MM	
				dr		WENDY CHEN 12/19/95		scale 1.5 : 1	
				enr		JOSEPH HSIA 12/19/95		dwg no	
				chr		JOSEPH HSIA 12/19/95		88640	
				appd		JENN TSAO 12/19/95		sheet 6 of 6 size	
								A4	
sheet		revision						type	
index		sheet						CUSTOMER Drawing	

PDM: Rev:H

STATUS: Released

Printed: May 27, 2008

This document is the property of and embodies CONFIDENTIAL and PROPRIETARY information of FCI. No part of the information shown on this document may be used in any way or disclosed to others without the written consent of FCI. Copyright FCI.



FCIconnect.com